

Customer:

LEG ASSEMBLY

DWG#:

NUMBER REQUIRED:

SHOP ORDER #

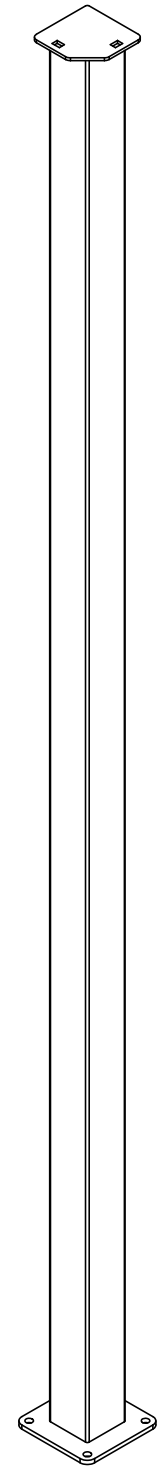
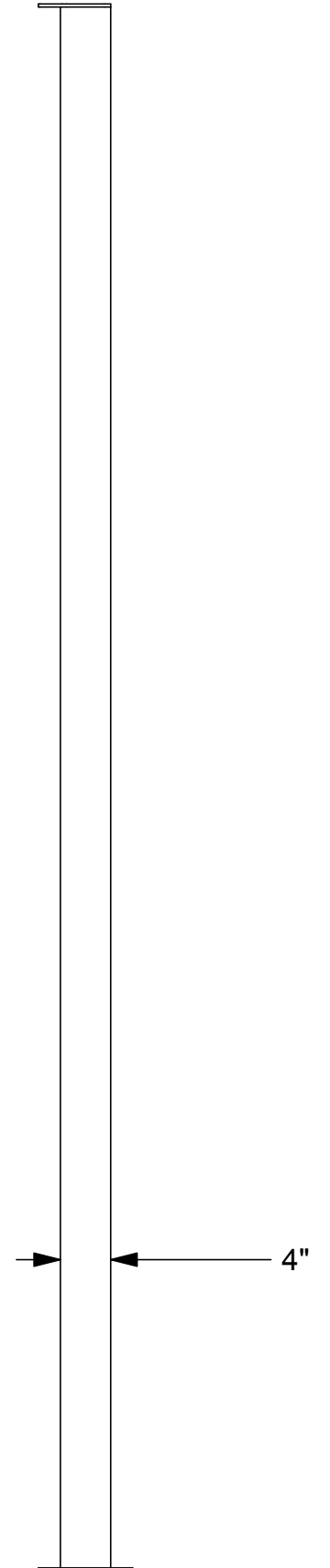
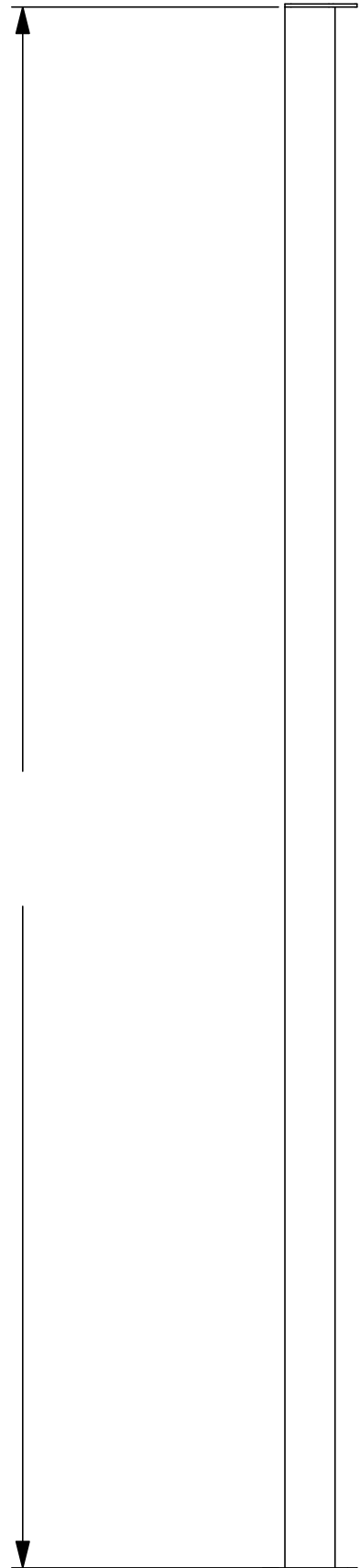

Customer:
LEG WELDMENT
DWG#:
NUMBER REQUIRED:
SHOP ORDER #

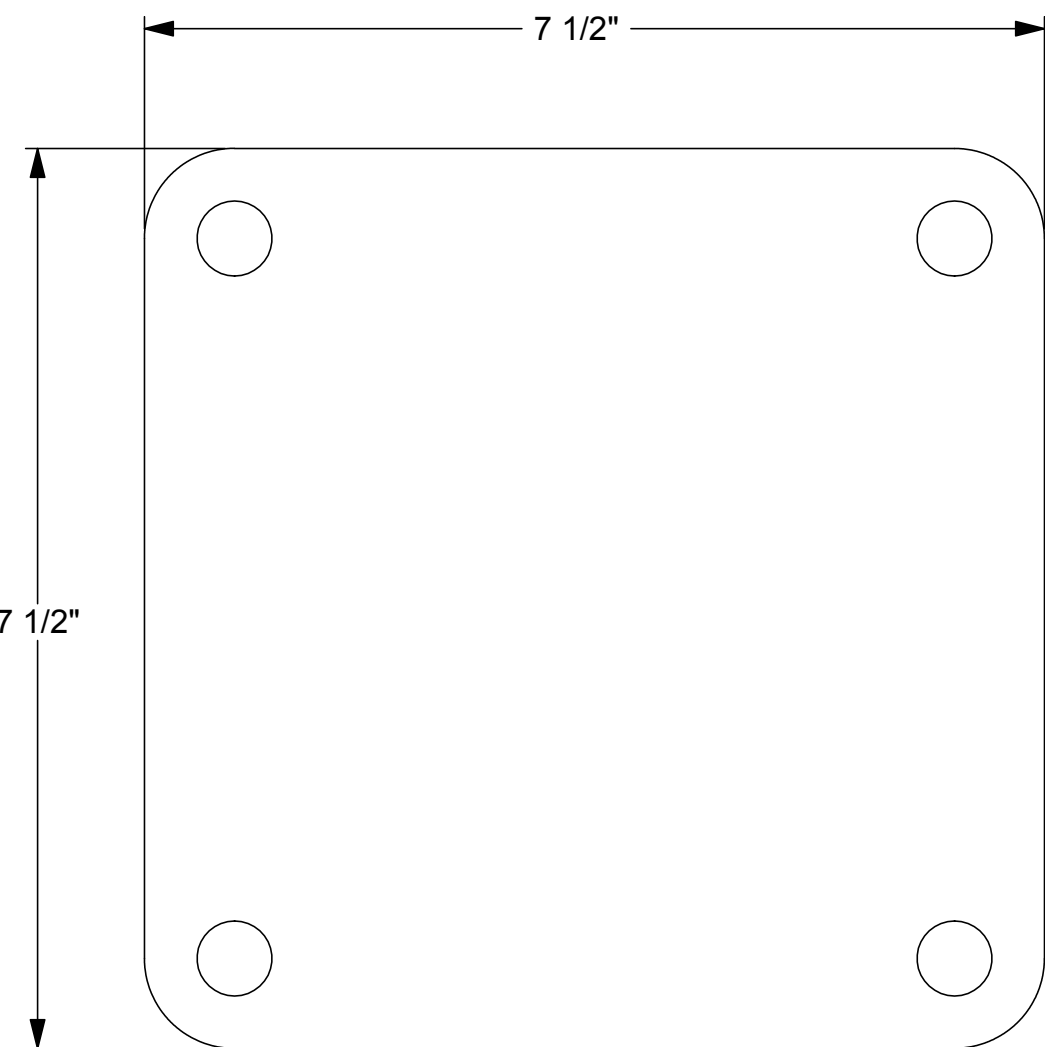

PART # LEG FOOT
 MATERIAL: 3/8" THICK
 CARBON STEEL
 QUANTITY: 4

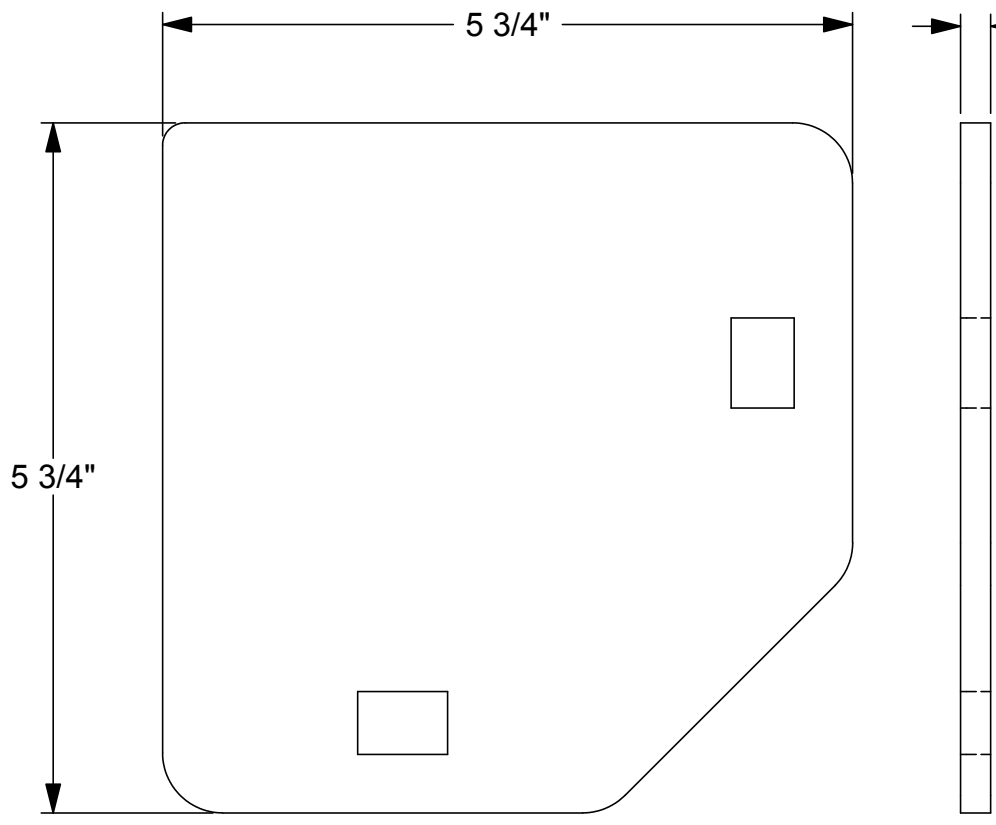
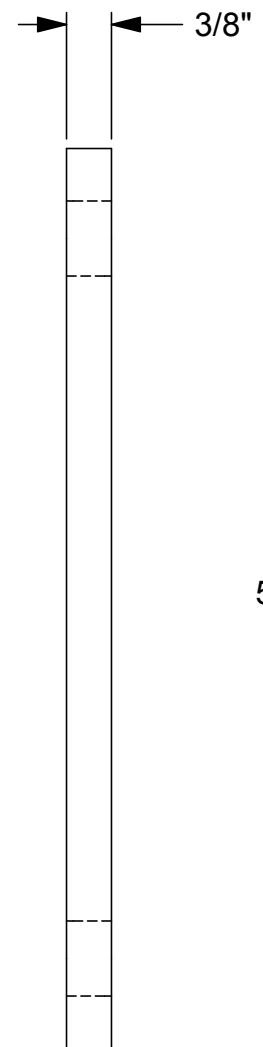

PART # LEG PAD
 MATERIAL: 1/4" THICK
 CARBON STEEL
 QUANTITY: 4

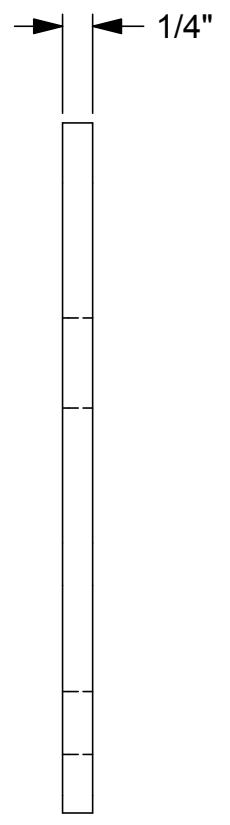

Customer:
 LEG ASSEMBLY
 DWG#:
 NUMBER REQUIRED:
 SHOP ORDER #

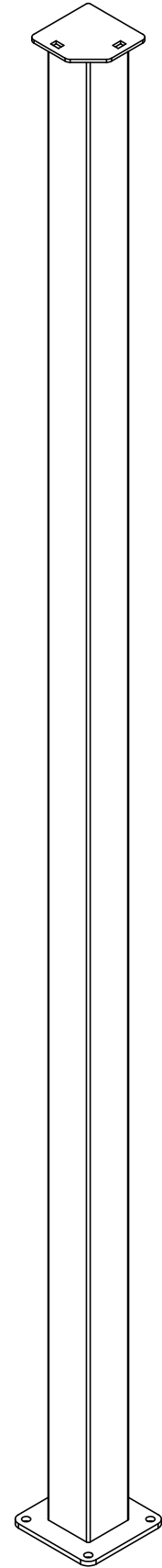

Customer:

LEG WELDMENT NO X-BRACE

DWG#:

NUMBER REQUIRED:

SHOP ORDER #